

THERMAL POWER EVALUATION OF THE TRIGA NUCLEAR REACTOR AT CDTN IN OPERATIONS OF LONG DURATION

Amir Zacarias Mesquita¹, amir@cdtn.br

Andrea Vidal Ferreira¹, avf@cdtn.br

Hugo Cesar Rezende¹, hcr@cdtn.br

¹Centro de Desenvolvimento da Tecnologia Nuclear/Comissão Nacional de Energia Nuclear (CDTN/CNEN)

Abstract. *The standard operations of nuclear research reactor IPR-R1 TRIGA located at CDTN (Belo Horizonte) usually have duration of not more than 8h. However in 2009 two operations for samples irradiations lasted about 12 hours each at a power of 100 kW. These long lasting operations started in the evening and most of them were carried out at night, when there are only small fluctuations in atmosphere temperature. Therefore the conditions were ideal for evaluating the thermal balance of the power dissipated by the reactor core through the forced cooling system. Heat balance is the standard methodology for power calibration of the IPR-R1 reactor. As in any reactor operation, the main operating parameters were monitored and stored by the Data Acquisition System (DAS) developed for the reactor. These data have been used for the analysis and calculation of the evolution of several neutronic and thermal-hydraulic parameters involved in the reactor operation. This paper analyzes the two long lasting operations of the IPR-R1 TRIGA and compares the recorded results for the power dissipated through the primary cooling loop with the results of the power calibration conducted in March 2009. The results corresponded to those of the thermal power calibration within the uncertainty of this methodology, indicating system stability over a period of six months.*

Keywords: *Thermal power; TRIGA nuclear reactor; nuclear research reactor; thermal balance, thermal hydraulic.*

1. INTRODUCTION

The IPR-R1 TRIGA Mark I nuclear research reactor at the Nuclear Technology Development Center - CDTN (Belo Horizonte) is an open pool type reactor. It was designed for research, training and radioisotope production. The fuel elements in the reactor core are cooled by water natural circulation. The heat removal capability of this process is sufficient to assure safe operations at the current maximum 250 kW power level configuration. Nevertheless a heat removal system is provided for removing heat from the reactor pool water. The water is pumped through a heat exchanger, where the heat is transferred from the primary to the secondary loop. The secondary loop water is cooled in an external cooling tower. A Data Acquisition System for monitoring and recording the operational parameters was developed in 2004 for the IPR-R1 TRIGA nuclear reactor. All operations of this reactor are currently recorded by this system (Mesquita and Souza, 2010). These data have been used for analysis and calculation of the evolution of several neutronic and thermal-hydraulic parameters involved in the reactor operation.

On July 3rd and August 13th, 2009, samples were irradiated in the IPR-R1 TRIGA reactor operating at 100 kW power for about 12 hours in each operation. These long lasting operations started in the evening and most of them were carried out at night, when there are only small fluctuations in atmosphere temperature. Therefore the conditions were ideal for evaluating the thermal balance of the power dissipated by the reactor core through the forced cooling system. Power data obtained in these two operations were compared with the results of the thermal power calibration carried out on March 5th, 2009 in the IPR-R1 TRIGA reactor. The standard thermal power calibration methodology of this reactor is the steady state heat balance in the primary cooling system (Mesquita *et al.* 2007).

Power monitoring of nuclear reactors is done by means of nuclear detectors which are calibrated by thermal methods. The type of chamber used and its position with respect to the core determine the range of measured neutron flux. In the IPR-R1 reactor four neutron-sensitive chambers (neutronic channel) are mounted around the reactor core for flux measurement, as described below:

- the departure channel consists of a fission counter with a pulse amplifier that feeds a logarithmic count rate circuit and provides a useful measurement of power, ranging from neutron source level to a few watts;
- the logarithmic channel consists of a compensated ion chamber feeding a period amplifier and a logarithmic (log n) recorder, which gives a logarithmic power measurement from less than 0.1 W to full power;
- the linear channel consists of a compensated ion chamber feeding a sensitive amplifier and recorder with a range switch, which gives accurate information on power from source level to full power on a linear recorder;
- the percent channel consists of an uncompensated ion chamber feeding a power level monitor circuit and meter, which is calibrated in terms of percentage of full power.

The nuclear instrumentation is used to detect neutrons when sub-critical multiplication occurs during the reactor start-up and to detect the variation of neutron flux after achieving criticality so as to obtain the automatic reactivity control that maintains the stability of the power level.

2. THEORETICAL BASIS

2.1 Power Calibration by the Heat Balance Method

The heat balance methodology for thermal power calibration consists mainly of measuring the power dissipated through the primary loop. The heat losses from the reactor pool to the environment are also added to the measured value. The closer the water temperature in the reactor pool is to the environment temperature, the closer the power dissipated at the cooling loop will be to the reactor power. This means that the reactor pool temperature must be set close to the soil temperature around the pool, and that the air temperature in the reactor room must be set close to that of the pool (Mesquita *et al.*, 2007). Therefore, it is important to ensure these conditions as well as the stability of the pool temperature over a long period of time (one and a half hours or longer). This can be obtained only after several hours of reactor operation, mainly at night, when there are only small external air temperature changes.

The thermal power dissipated through the primary loop can be calculated with a simple thermal balance obtained by measuring the values of the inlet and outlet temperatures of the water and its flow rate. The reactor thermal power is obtained by adding this value to the thermal losses. These losses represent a very small fraction of the total power. The power dissipated in the secondary loop was also measured by a thermal balance.

The power (q) was obtained through a thermal balance given by the following equation:

$$q = \dot{m} c_p \Delta T \quad (1)$$

where \dot{m} is the flow rate of the coolant water in the primary loop, c_p is the specific heat of the coolant, and ΔT is the difference between the temperatures at the inlet and the outlet of the primary loop. The data acquisition computer program calculates the power dissipated in the cooling loop using the collected data, with \dot{m} and c_p values corrected as a function of the coolant temperature (Miller, 1989).

2.2 Heat Losses from the Reactor Pool to the Environment

The core of the TRIGA Mark I IPR-R1 nuclear reactor is placed below the room floor, at the bottom of a cylindrical pool 6.417 m deep and 1.92 m in diameter. The reactor pool was built as a five layer cylindrical tank, open at the top as shown in Fig. (1). The innermost layer, which is in contact with the water, is 10 mm thick and is made of a special alloy of aluminum (AA-5052-H34). Surrounding it is a 72 mm thick layer of concrete, followed by a 6.3 mm thick stainless steel layer. After that is another concrete layer 203 mm thick and finally another stainless steel layer 6.3 mm thick. The reactor pool transfers heat to the environment by conduction to the soil, through the lateral walls and the bottom of the pool, as well as by convection and evaporation to the air in the reactor room, through the upper surface. In specific experiments performed for reactor power calibration, the equations for heat transfer by conduction convection and evaporation are included in the data acquisition system software. These equations calculate the losses as a function of water, air and soil temperatures, and consider the thermal resistance of the tank wall components, and the heat exchange by evaporation and convection on the pool water surface.

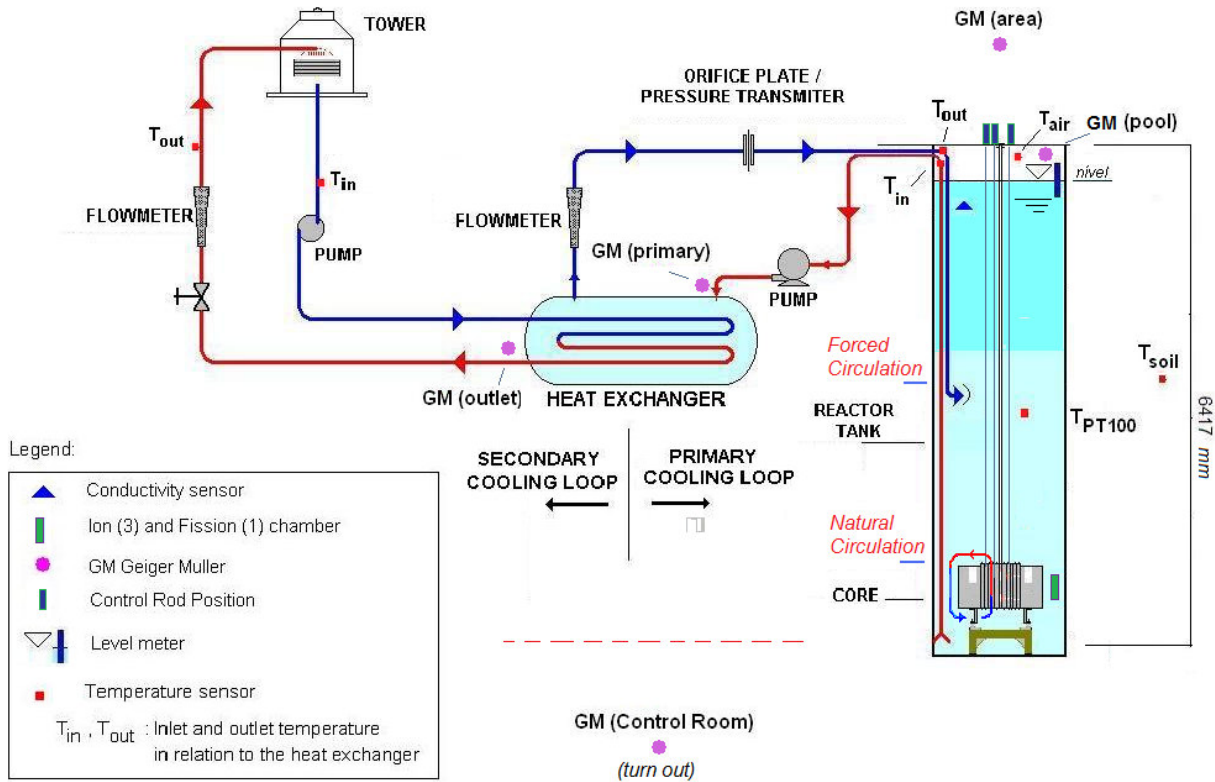

Figure 1. IPR-R1 TRIGA reactor cooling system diagram and instrumentation distribution.

2.3 Thermal Power Uncertainties

The thermal power dissipated through the primary cooling loop was calculated by Eq. (1) or:

$$q = \dot{m} c_p (T_{in} - T_{out}) . \quad (2)$$

The power uncertainty was calculated considering the uncertainties of: the measured flow rate (\dot{m}), the inlet and outlet temperatures ($T_{in} - T_{out}$) in the heat exchanger and also the water heat capacity (c_p) as function of temperature.

The power uncertainty (U'_q) is given by the following equation (Figliola, 1991) (Holman, 1998):

$$U'_q = \sqrt{\left(\frac{\partial q}{\partial \dot{m}} U_{\dot{m}}\right)^2 + \left(\frac{\partial q}{\partial c_p} U_{c_p}\right)^2 + \left(\frac{\partial q}{\partial T_{in}} U_{T_{in}}\right)^2 + \left(\frac{\partial q}{\partial T_{out}} U_{T_{out}}\right)^2} \quad (3)$$

where: $U_{\dot{m}}$, U_{c_p} , $U_{T_{in}}$ and $U_{T_{out}}$ are the consolidated uncertainties of the independent primary variables: \dot{m} , c_p , T_{in} and T_{out} . The following expression for the relative uncertainty value for the thermal power was obtained by solving Eq. (3):

$$\frac{U'_q}{q} = \sqrt{\left(\frac{U_{\dot{m}}}{\dot{m}}\right)^2 + \left(\frac{U_{c_p}}{c_p}\right)^2 + \left(\frac{U_{T_{in}}}{T_{in} - T_{out}}\right)^2 + \left(\frac{U_{T_{out}}}{T_{in} - T_{out}}\right)^2} . \quad (4)$$

This value should be added to the standard deviation (S_q) of the measured average power to obtain the actual uncertainty:

$$\frac{U_q}{q} = \sqrt{\left(\frac{U'_q}{q}\right)^2 + \left(\frac{S_q}{q}\right)^2} \quad (5)$$

3. THERMAL POWER CALIBRATION ON MARCH 5, 2009

On March 5th, 2009 the annual power calibration of the IPR-R1 TRIGA reactor (Mesquita *et al.* 2009) was conducted, as established by the Safety Analysis Report for the reactor (CDTN/CNEN, 2008). The reactor was critical at 100 kW (power indicated in the linear neutronic channel) with the forced refrigeration turned off. After 2 hours of operation the forced cooling system was turned on, and the reactor operated during a period of about 7 hours. The power dissipated through the primary and the secondary cooling loops was monitored during the whole test period, and the measured temperatures were stable for 84 min. Figure 2 shows the temperature evolution during the heat balance calibration. Figure 3 shows the thermal power evolution dissipated in the cooling system during the stable period. The thermal power obtained in the thermal calibration was 112 ± 7 kW (Mesquita *et al.* 2009).

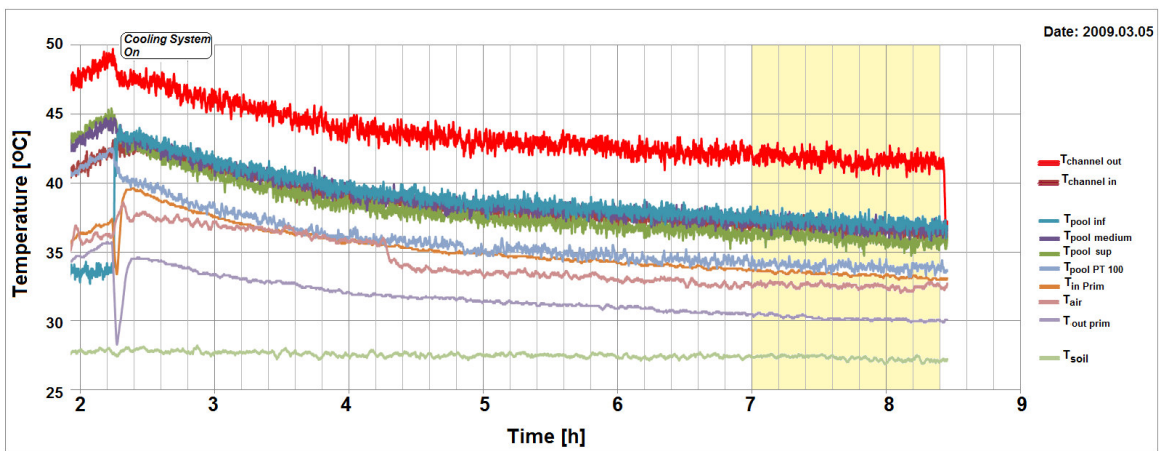

Figure 2. Temperature evolution in the thermal calibration.

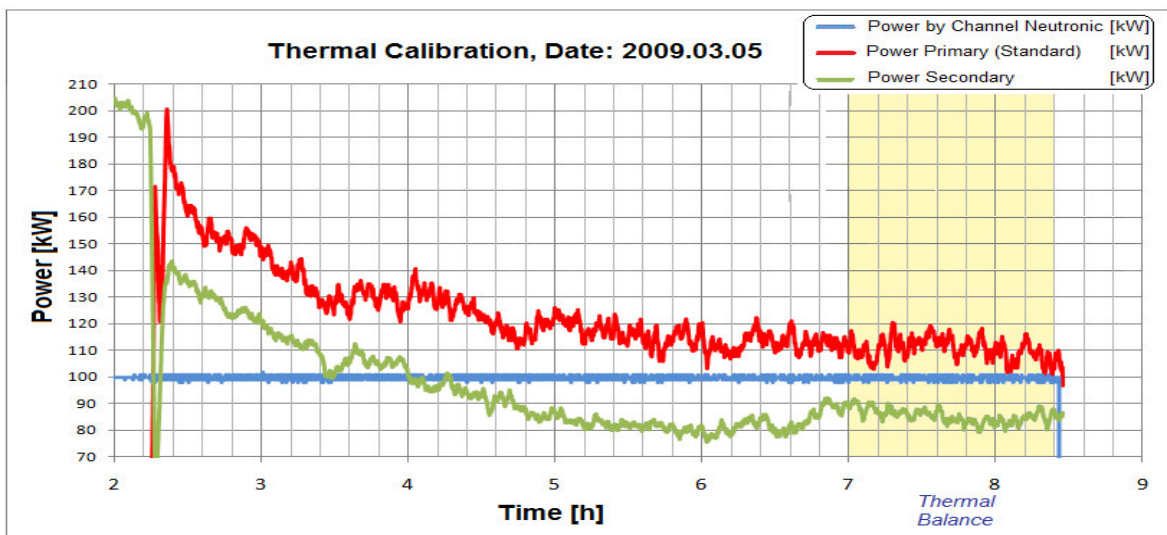

Figure 3. Power evolution in the thermal calibration.

4. EXPERIMENTAL METODOLOGY

Two platinum resistance thermometers (PT-100) were positioned at both the inlet and the outlet of the primary cooling loop, just above the water surface of the reactor pool (see T_{in} and T_{out} in Fig. 1). A system consisting of an orifice plate and a differential pressure transmitter measured the flow rate through the primary loop. A type K thermocouple was placed just above the pool surface to measure the air temperature in the reactor room and another in a hole in the reactor room floor to measure the soil temperature in order to calculate the thermal losses (Fig. 1). For the measurement of the power dissipated in the secondary cooling loop, two resistance thermometers (PT-100) were also positioned at the inlet and outlet. The water flow rate at this loop was also measured and maintained constant. The temperature and pressure measuring lines were calibrated as a whole, including pressure transmitter, thermometers, cables, data acquisition cards and computer.

The sensor signals were transmitted to an amplifier and multiplexing board, which also performs the temperature compensation for the thermocouples. These signals were sent to a data acquisition card that performs the analog / digital conversion. This card was positioned inside a computer where the data were processed and recorded. All data were obtained as the average of 120 measurements and were recorded together with their standard deviations. The measuring frequency of the data acquisition system is 1Hz (Mesquita and Rezende, 2004).

5. RESULTS

5.1. Power Monitoring in the Irradiation on July 3, 2009

The reactor operated for a period of about 13 hours. The power dissipated in the primary and secondary circuits was monitored by the Data Acquisition System which was turned on after the reactor became critical. The optimum period of thermal equilibrium (steady state) was considered as being from 11 to 12 hours after the operation had started (at about 4:00am to 5:00am). Figure (4) shows the temperature evolution in the water pool and in the environment throughout the experiment. Figure (5) shows the evolution of the following parameters: power dissipated in the primary and secondary circuit and the power measured at the linear neutron channel. The period considered as presenting the best thermal equilibrium is highlighted in the graphics. The power obtained in this irradiation by the primary loop heat balance method was 104 ± 6 kW.

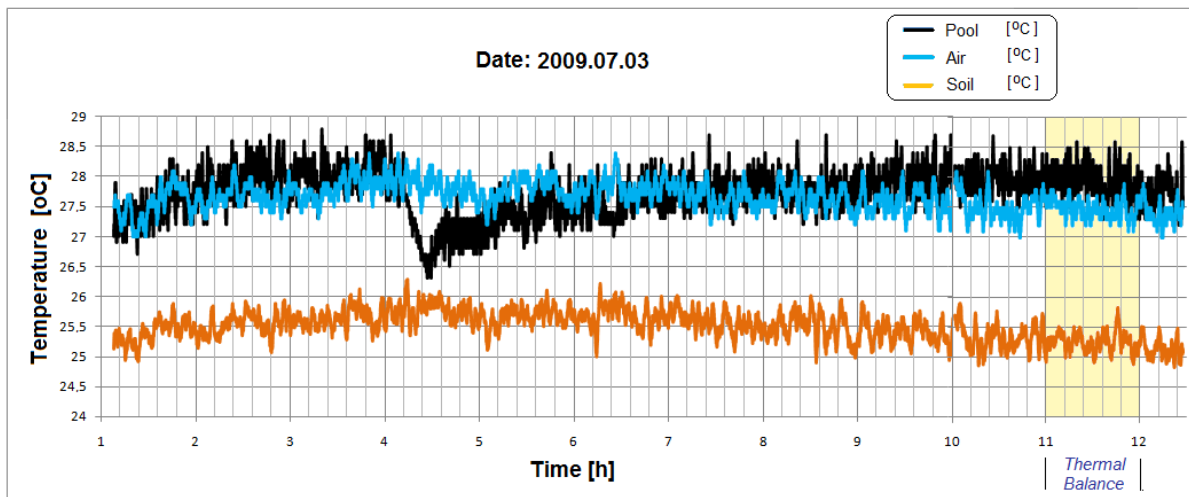

Figure 4. Temperature evolution during the July 3rd 2009 operation.

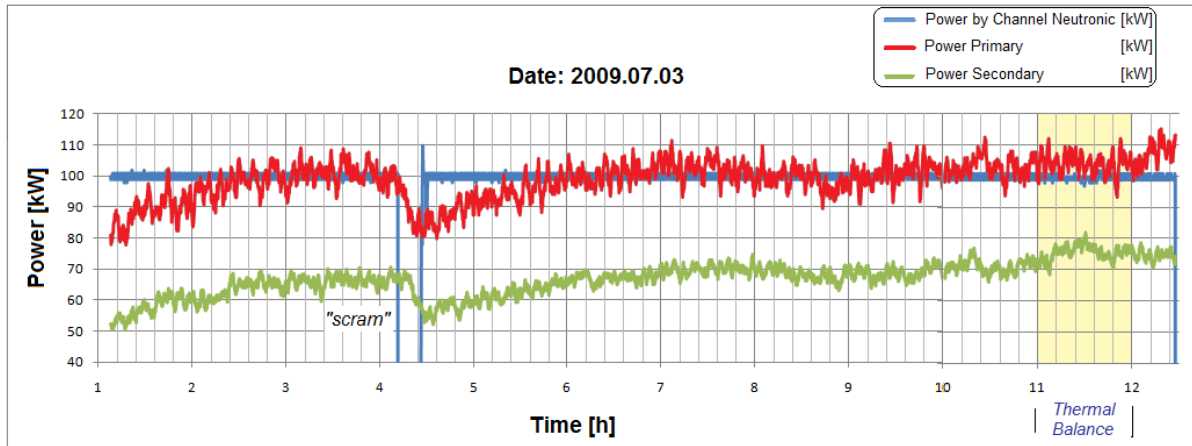

Figure 5. Power evolution during the July 3rd 2009 operation.

5.2 Power Monitoring in the Irradiation on August 13th, 2009

In this operation the reactor irradiated samples for a period of 12 hours. The optimum period of thermal stability was considered to be from 10 to 11 hours after the start of the operation. Figure (6) shows the temperature evolution throughout the experiment. Figure (7) shows the power evolution throughout the operation, highlighting the steady-state period. The power obtained was 107 ± 6 kW.

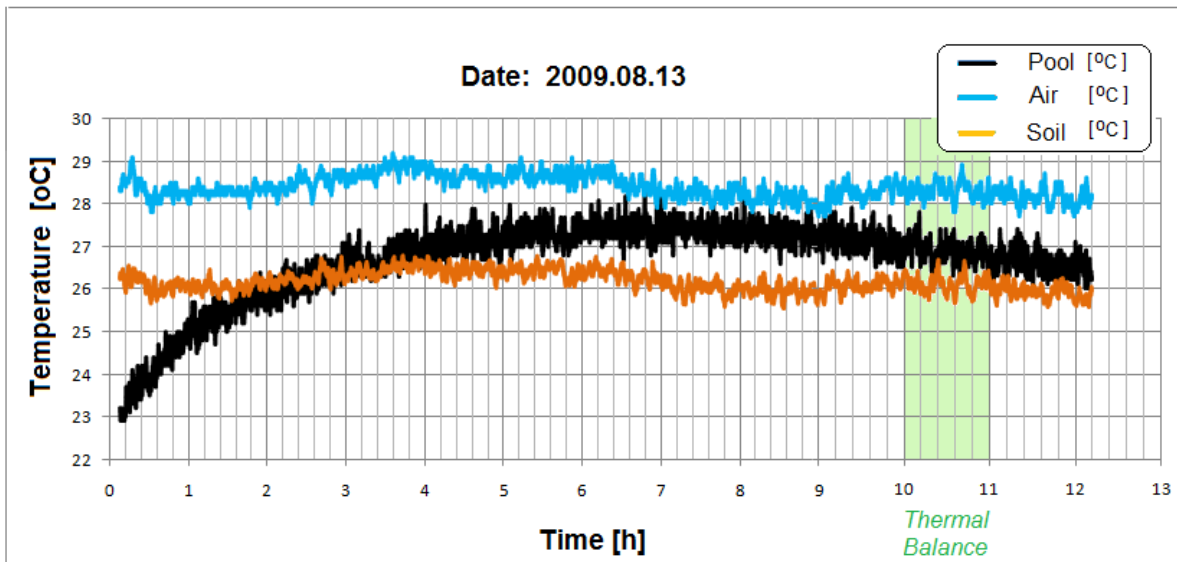

Figure 6. Temperature evolution during the August 13th 2009 operation.

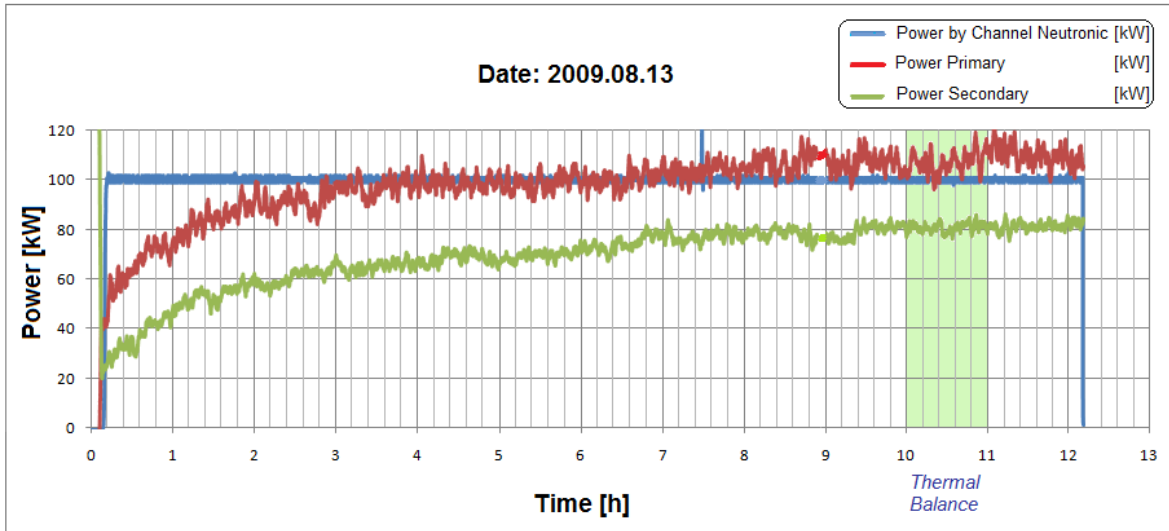

Figure 7. Power evolution during the August 13th 2009 operation.

5.3. Discussion

Table 1 shows the consolidated results of the two long lasting reactor operations and the results of the annual power calibration of the IPR-R1TRIGA (Mesquita *et al.* 2009) carried out on March 5th, 2009. The heat losses from the water pool were approximately 1.4 kW in all tests. This value corresponds to approximately 1.25% of total power.

Table 1. Parameters and results of the power monitoring by the heat balance method.

Date and Duration	Average Primary Flow [m ³ /h]	Primary Inlet Average Temperature [°C]	Primary Outlet Average Temperature [°C]	Primary Loop Power [kW]	Secondary Loop Power [kW]	Reactor ⁽¹⁾ Power [kW]
2009.07.03 13h	30.27	27.4	24.4	103 ± 3	75.8	104 ± 6
2009.08.13 12h	30.81	26.3	23.3	106 ± 4	80.9	107 ± 6
⁽²⁾ 2009.03.05 8:30 h	30.09	33.4	30.2	111 ± 4	85.2	112 ± 7

⁽¹⁾ Power including thermal losses.

⁽²⁾ (Mesquita *et al.* 2009).

Table 1 shows that the power measurements during long lasting irradiations correspond to the March 2009 power calibration. That means that the reactor power measuring system is stable and does not require any adjustment. The Safety Analysis Report (SAR) of the IPR-R1 TRIGA requires the annual calibration of the thermal reactor power (CDTN/CNEN, 2008). Our results show that the annual calibration is still valid after six months.

4. CONCLUSION

The heat balance in the primary loop is the standard procedure for calibrating the thermal power of the IPR-R1 TRIGA Mark I nuclear reactor. The last experiment for calibration of the power of the IPR-R1 was performed in March 2009 (Mesquita and Rezende, 2010). Data analysis from two long lasting irradiations carried out some months later shows that the measured thermal power corresponds to the results from the annual calibration, indicating the system stability.

5. ACKNOWLEDGEMENTS

The authors express their thanks to the *Fundação de Amparo à Pesquisa do Estado de Minas Gerais (FAPEMIG)* and to the *Conselho Nacional de Desenvolvimento Científico e Tecnológico (CNPq)* for the financial support.

6. REFERENCES

- CDTN/CNEN, 2008. "Relatório de Análise de Segurança do Reator TRIGA IPR-R1". Belo Horizonte, RASIN/TRIGA-IPR-R1/CDTN.
- Figliola, R. S. and Beasley, D. E., 1991. "Theory and Design for Mechanical Measurements", John Wiley & Sons, New York.
- Holman, J. P., 1998. "Experimental Methods for Engineers", 7th ed. McGraw-Hill Book Company, Boston.
- Mesquita, A.Z. and Rezende, H.C., 2004. "Data Acquisition System for TRIGA Mark I nuclear Research Reactor of CDTN". Proceedings of the America Nuclear Energy Symposium (ANES 2004), Miami Beach, Flórida, USA. America Nuclear Energy.
- Mesquita, A.Z., Rezende, H.C. and Tambourgi, E.B., 2007. "Power Calibration of the TRIGA Mark I Nuclear Research Reactor". Journal of the Brazilian Society of Mechanical Sciences and Engineering, v. XXIX, p. 240-245.
- Mesquita, A.Z., Souza, R.M.G.P., Rezende, H.C. "Thermal Power calibrations of the IPR-R1 TRIGA nuclear reactor" In: 20th International Congress of Mechanical Engineering - COBEM 2009, 2009, Gramado - RS. 20th International Congress of Mechanical Engineering - COBEM 2009. Rio de Janeiro:Associação Brasileira de Engenharia e Ciências Mecânicas - ABCM, 2009.
- Mesquita, A.Z. and Rezende, H.C., 2010, "Thermal Methods for On-Line Power Monitoring of the IPR-R1 TRIGA Reactor", Progress in Nuclear Energy. v. 52, p. 292-297.
- Mesquita, A.Z. and Souza, R.M.G.P., 2010. "On-line Monitoring of the IPR-R1 TRIGA Reactor Neutronic Parameters". Progress in Nuclear Energy. v. 52, p. 268-272.
- Miller, R.W., 1989. "Flow Measurement Engineering Handbook", 2nd. Ed. New York, McGraw-Hill Publishing Company. p. E19-E21.

7. RESPONSIBILITY NOTICE

The authors are the only responsible for the printed material included in this paper.